

KT-MSLED25PS-2-8CSA-VDIM

MICROSTRIP FIXTURE

DESCRIPTION

2' LED Microstrip Fixture | 120 – 277V Input |
Frosted Lens | 0 – 10V Dimming

APPLICATION

Used for commercial, retail, and residential strip applications



PRODUCT FEATURES

- Features Keystone Color Select technology. Adjust CCT between 3500K, 4000K, or 5000K
- Features Keystone Power Select technology. Adjust power between 25W, 20W, and 15W
- Luminaire is suitable for installation within a clothes closet storage space
- Powered by Keystone 0 – 10V dimming LED drivers
- Post-painted steel body; PMMA lens
- Compatible with Keystone occupancy sensors
- Ambient operating temperature: -20°C/-4°F to 50°C/122°F
- UL Listed 1598: Suitable for dry and damp locations
- THD: < 20%
- Power factor > 0.95

POWER AND COLOR TEMPERATURE SELECTABILITY

- Keystone Color Select Technology: Adjustable CCT (3500K/4000K/5000K)
- Keystone Power Select Technology: Adjustable Wattage (25W/20W/15W)

PRODUCT SPECIFICATIONS

| Catalog Number | Input Voltage | Wattage | CCT | Lumen Output | Efficacy | CRI | Power Factor | Lifetime |
|--------------------------|---------------|---------|-------|--------------|----------|------|--------------|------------|
| KT-MSLED25PS-2-8CSA-VDIM | 120–277V | 25W | 3500K | 3,250 | 130 lm/W | > 80 | > 0.90 | 50,000 hrs |
| | | | 4000K | 3,275 | 131 lm/W | | | |
| | | | 5000K | 3,300 | 132 lm/W | | | |
| | | 20W | 3500K | 2,720 | 136 lm/W | | | |
| | | | 4000K | 2,740 | 137 lm/W | | | |
| | | | 5000K | 2,760 | 138 lm/W | | | |
| | | 15W | 3500K | 2,085 | 139 lm/W | | | |
| | | | 4000K | 2,100 | 140 lm/W | | | |
| | | | 5000K | 2,115 | 141 lm/W | | | |

ONE CATALOG NUMBER WITH 9 DIFFERENT OPTIONS

* Preset to highest lumen output (25W / 5000K)
* Color Uniformity: CCT (Correlated Color Temperature) range as per guidelines outlined in ANSI C78.377-2017.

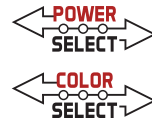

KT-MSLED25PS-2-8CSA-VDIM

MICROSTRIP FIXTURE

PHOTOMETRIC SPECIFICATIONS

ISOCANDELA PLOT

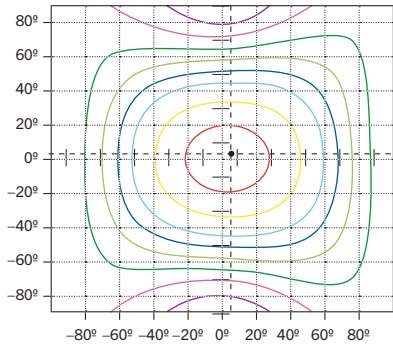

- Cd: 891, 90%
 - Cd: 743, 75%
 - Cd: 594, 60%
 - Cd: 495, 50%
 - Cd: 396, 40%
 - Cd: 297, 30%
 - Cd: 198, 20%
 - Cd: 99, 10%
- Point of Max Cd: 990.5

POLAR CANDELA DISTRIBUTION

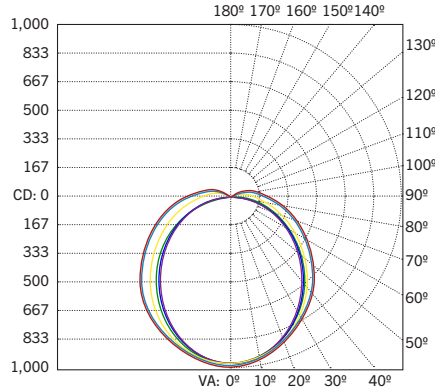

- Max Cd: 315° H
- 0° H
- 90° H
- 22.5° H
- 45° H
- 67.5° H

ZONAL LUMEN SUMMARY

| Zone | Lumens | % Luminaire |
|--------|---------|-------------|
| 0-60 | 2,215.2 | 65.40% |
| 60-90 | 884.3 | 26.10% |
| 0-90 | 3,099.5 | 91.50% |
| 90-180 | 289.5 | 8.50% |
| 0-180 | 3,389.0 | 100.0% |

PHYSICAL SPECIFICATIONS

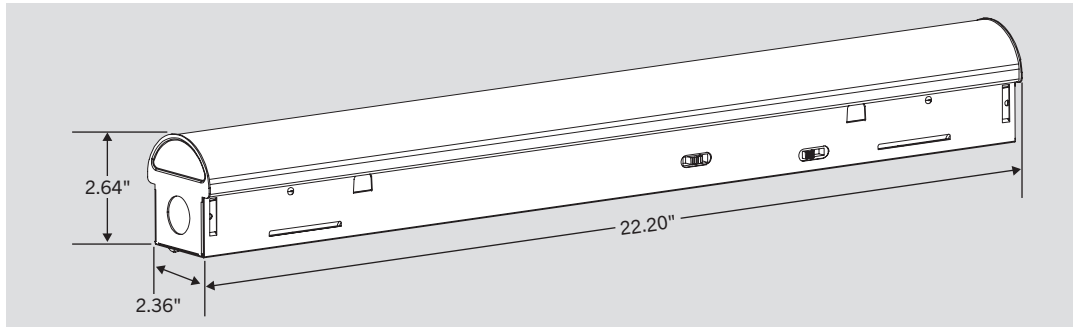

WIRING DIAGRAMS

0-10V Dimmer

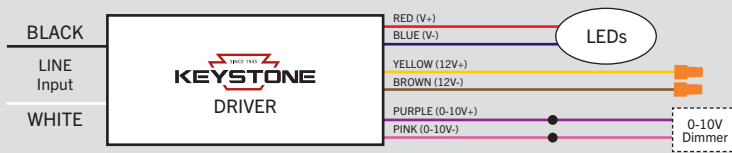

KTSL-FC2-12V-SM-PIR Fixture Controller/Sensor

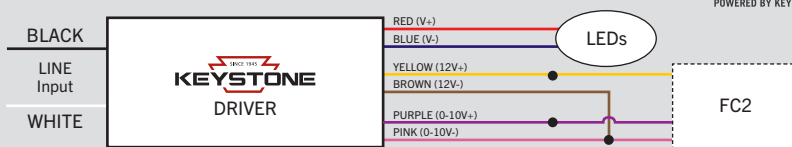

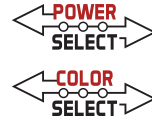

KT-MSLED25PS-2-8CSA-VDIM

MICROSTRIP FIXTURE

SENSORS (SOLD SEPARATELY)

| ORDER CODE | DESCRIPTION |
|----------------------|--|
| KTSL-FC2-12V-SM-PIR* | Bluetooth mesh wireless low voltage fixture controller for SmartLoop system with integrated daylight and PIR motion |
| KTS-MW3-UV-KO-K2 | Microwave Sensor Kit, includes 120-277V input to 12V DC convector, 12V input sensor head, Nomex Sleeve, Extension Neck |



*Requires KT-MSLED-SLB-1 mounting bracket

Fixture installed with KTSL-FC2-12V-SM-PIR and KT-MSLED-SLB-1 bracket

ACCESSORIES (SOLD SEPARATELY)

| ORDER CODE | DESCRIPTION |
|------------------|--|
| KT-MSLED-LSM-KIT | Linking Surface Mount Kit for MSLED fixtures. Includes end to end metal bracket and KO grommet |
| KT-MSLED-VH-KIT | V-Hook and Chain Kit for Keystone Micro LED Strip fixtures. Includes (2) V-Hook and (2) chains 40in long |
| KT-MSLED-SLB-1 | Microstrip Bracket for Smart Loop KTSL-FC2-12V-SM-PIR Sensor |

ORDERING INFORMATION

| Catalog Number | Pack Quantity | Easy Code | UPC |
|--------------------------|---------------|-----------|--------------|
| KT-MSLED25PS-2-8CSA-VDIM | TBD | MTU-40 | 843654134895 |

CATALOG NUMBER BREAKDOWN

KT-MSLED25PS-2-8CSA-VDIM

1
2
3
4
5
6
7
8
9
10

- 1** Keystone Technologies
- 2** LED Microstrip Fixture
- 3** Wattage
- 4** Power Select
- 5** 2' Nominal Length
- 6** 800 Series
- 7** Color Select
- 8** Color Select Designation
- 9** 0–10V Dimming
- 10** Sensor Options

8 Color Select Designation

| | |
|---|---------------------|
| A | 3500K, 4000K, 5000K |
|---|---------------------|

10 Sensor Options

| | No Option |
|----------|-------------------------------|
| /FC2-PIR | SmartLoop PIR sensor included |
| /MW | Microwave Sensor included |