



ADVANTA_{EMRG}



KT-RDLEDXXPS-XA-9CSF-EM4 LED RECESSED EMERGENCY DOWNLIGHT

DESCRIPTION

LED Recessed Emergency Downlight | Power Select Technology | Color Select Technology | Features Built-In 4W Emergency Pack

APPLICATION

Ideal for hospitality, retail, office, and other retrofit and new construction applications



**5 YEAR
WARRANTY**

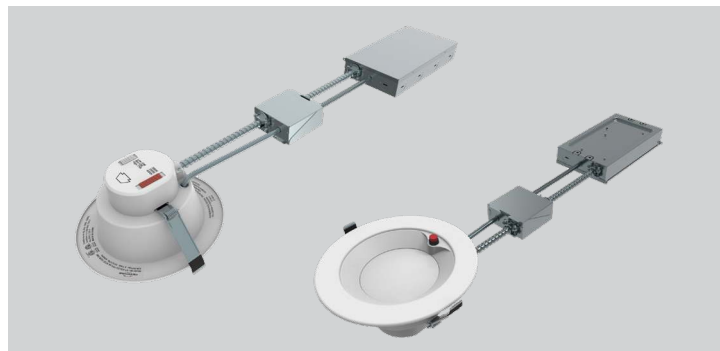

PRODUCT FEATURES

- Complete, pre-wired emergency downlight solution—including test button—removes all typical guesswork, uncertainty, and complex installation issues from battery backup downlight applications
- Keystone Power Select and Color Select technologies offer SKU reduction and allow for easy, on-the-job adjustments
- Built-in 4W LED Keystone SmartSafe emergency driver that is compliant with CEC T20
- Battery uses LifePO4 technology
- Designed with junction box and quick disconnects for easy installation
- Ideal for new construction, remodeling, and retrofit applications
- Smooth reflector trim offers clean, modern appearance
- Diffused lens reduces glare
- Interchangeable trims available in matte black and brushed nickel
- Powered by Keystone 0–10V dimming LED driver; 10–100% dimming
- Ambient operating temperature: 0°C/32°F to 40°C/104°F
- Suitable for use in dry and damp locations
- Airtight and Type IC-rated
- Power Factor: ≥ 0.90
- THD: $< 20\%$
- LED chip lifetime: L70 $> 80,000$ hrs @ 25°C/77°F ambient fixture temp
- FCC Part 15, Subpart B, Class A

PERFORMANCE SPECIFICATIONS OVERVIEW

Catalog Number	Input Voltage	Selectable Wattage	Selectable CCT	Lumen Output	Efficacy	Emergency Wattage	Emergency Lumen Output	CRI	Power Factor	Lifetime
KT-RDLED24PS-6A-9CSF-VDIM-EM4		24W	2700K	2,450	102 lm/W					
		21W	3000K	2,300	110 lm/W					
		18.5W	3500K	2,150	116 lm/W					
		13W	4000K	1,600	123 lm/W					
		9.5W	5000K	1,200	126 lm/W					
KT-RDLED30PS-8A-9CSF-VDIM-EM4	120–277V	30W	2700K	3,000	100 lm/W	4W	400	> 90	> 0.9	50,000 hrs
		27W	3000K	3,100	115 lm/W					
		23W	3500K	2,700	117 lm/W					
		20W	4000K	2,450	123 lm/W					
		16W	5000K	2,050	128 lm/W					
KT-RDLED38PS-10A-9CSF-VDIM-EM4		38W	2700K	3,850	101 lm/W					
		32W	3000K	3,600	113 lm/W					
		28W	3500K	3,300	118 lm/W					
		24W	4000K	2,900	121 lm/W					
		20W	5000K	2,550	128 lm/W					

* Preset to highest CCT: 4000K

Color Uniformity: CCT (Correlated Color Temperature) range as per guidelines outlined in ANSI C78.377-2017

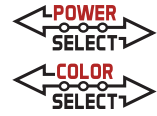

KT-RDLEDXXPS-XA-9CSF-EM4

LED RECESSED EMERGENCY DOWNLIGHT

PERFORMANCE SPECIFICATIONS DETAILED

Catalog Number	Input Voltage	Selectable Wattage	Selectable CCT	Lumen Output	Efficacy	Emergency Wattage	Emergency Lumen Output	CRI	Power Factor	Lifetime
KT-RDLED24PS-6A-9CSF-VDIM-EM4	120-277V	24W	2700K	2,450	102 lm/W	4W	400	> 90	> 0.9	50,000 hrs
			3000K	2,600	108 lm/W					
			3500K	2,700	113 lm/W					
			4000K	2,750	115 lm/W					
			5000K	2,750	115 lm/W					
		21W	2700K	2,200	105 lm/W					
			3000K	2,300	110 lm/W					
			3500K	2,350	112 lm/W					
			4000K	2,400	114 lm/W					
			5000K	2,400	114 lm/W					
		18.5W	2700K	1,950	105 lm/W					
			3000K	2,000	108 lm/W					
			3500K	2,150	116 lm/W					
			4000K	2,200	119 lm/W					
			5000K	2,200	119 lm/W					
		13W	2700K	1,450	112 lm/W					
			3000K	1,500	115 lm/W					
			3500K	1,550	119 lm/W					
			4000K	1,600	123 lm/W					
			5000K	1,600	123 lm/W					
9.5W	2700K	1,050	111 lm/W							
	3000K	1,100	116 lm/W							
	3500K	1,150	121 lm/W							
	4000K	1,200	126 lm/W							
	5000K	1,200	126 lm/W							
KT-RDLED30PS-8A-9CSF-VDIM-EM4	120-277V	30W	2700K	3,000	100 lm/W	4W	400	> 90	> 0.9	50,000 hrs
			3000K	3,300	110 lm/W					
			3500K	3,400	113 lm/W					
			4000K	3,400	113 lm/W					
			5000K	3,350	112 lm/W					
		27W	2700K	2,900	107 lm/W					
			3000K	3,100	115 lm/W					
			3500K	3,200	119 lm/W					
			4000K	3,200	119 lm/W					
		23W	5000K	3,200	119 lm/W					
			2700K	2,400	104 lm/W					
			3000K	2,600	113 lm/W					
			3500K	2,700	117 lm/W					

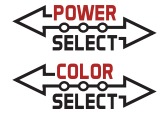

KT-RDLEDXXPS-XA-9CSF-EM4

LED RECESSED EMERGENCY DOWNLIGHT

PERFORMANCE SPECIFICATIONS DETAILED (CONTINUED)

KT-RDLED30PS-8A-9CSF-VDIM-EM4	120-277V	23W	4000K	2,700	117 lm/W	4W	400	> 90	> 0.9	50,000 hrs
			5000K	2,700	117 lm/W					
		20W	2700K	2,200	110 lm/W					
			3000K	2,400	120 lm/W					
			3500K	2,450	123 lm/W					
			4000K	2,450	123 lm/W					
			5000K	2,450	123 lm/W					
		16W	2700K	1,850	116 lm/W					
			3000K	1,950	122 lm/W					
			3500K	2,050	128 lm/W					
			4000K	2,050	128 lm/W					
			5000K	2,050	128 lm/W					
		KT-RDLED38PS-10A-9CSF-VDIM-EM4	120-277V	38W	2700K					
3000K	4,200				111 lm/W					
3500K	4,300				113 lm/W					
4000K	4,300				113 lm/W					
5000K	4,250				112 lm/W					
32W	2700K			3,300	103 lm/W					
	3000K			3,600	113 lm/W					
	3500K			3,700	116 lm/W					
	4000K			3,700	116 lm/W					
	5000K			3,650	114 lm/W					
28W	2700K			3,000	107 lm/W					
	3000K			3,200	114 lm/W					
	3500K			3,300	118 lm/W					
	4000K			3,300	118 lm/W					
	5000K			3,250	116 lm/W					
24W	2700K			2,600	108 lm/W					
	3000K			2,800	117 lm/W					
	3500K			2,900	121 lm/W					
	4000K			2,900	121 lm/W					
	5000K			2,850	119 lm/W					
20W	2700K			2,300	115 lm/W					
	3000K			2,500	125 lm/W					
	3500K			2,600	130 lm/W					
	4000K			2,600	130 lm/W					
	5000K			2,550	128 lm/W					

* Preset to highest CCT: 4000K
 Color Uniformity: CCT (Correlated Color Temperature) range as per guidelines outlined in ANSI C78.377-2017



KT-RDLEDXXPS-XA-9CSF-EM4

LED RECESSED EMERGENCY DOWNLIGHT

PHOTOMETRIC SPECIFICATIONS

KT-RDLED24PS-6A-9CSF-VDIM-EM4 POLAR CANDELA DISTRIBUTION

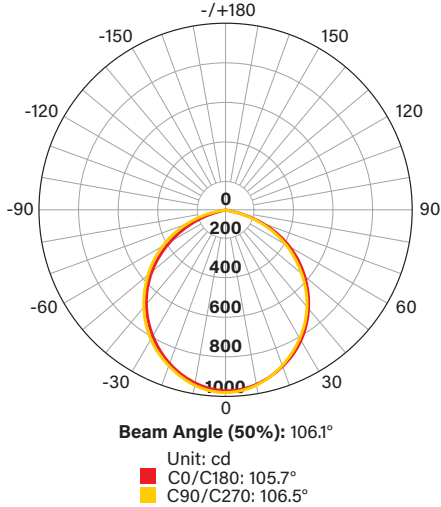

ISOCANDELA PLOT

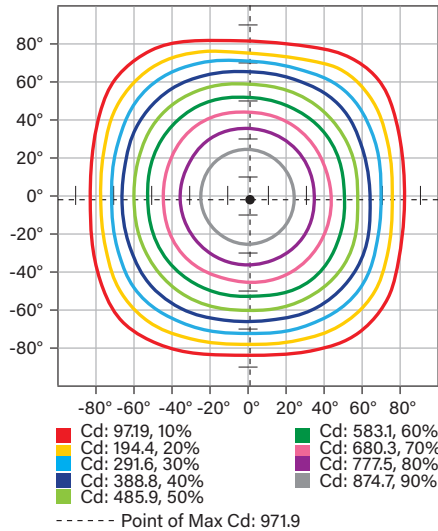

LUX DISTANCE CURVE

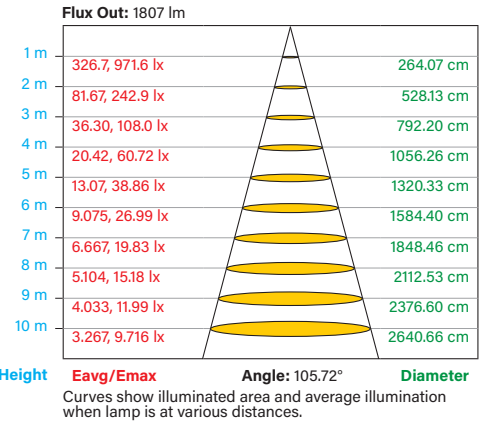

KT-RDLED30PS-8A-9CSF-VDIM-EM4 POLAR CANDELA DISTRIBUTION

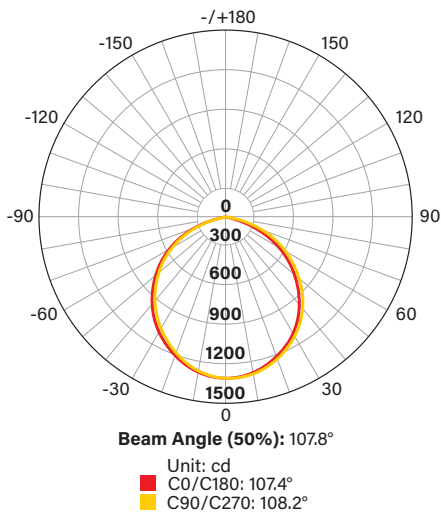

ISOCANDELA PLOT

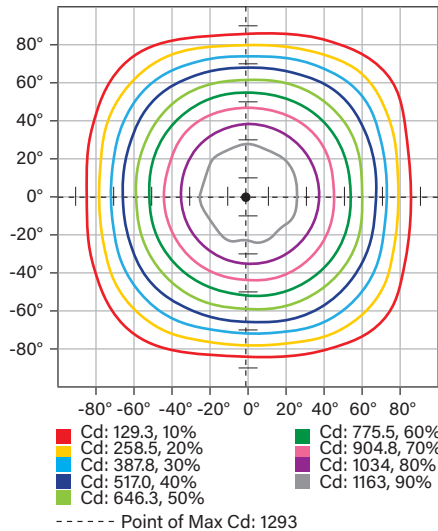

LUX DISTANCE CURVE

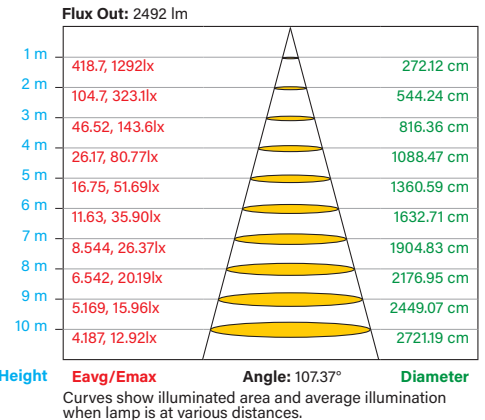

KT-RDLEDXXPS-XA-9CSF-EM4

LED RECESSED EMERGENCY DOWNLIGHT

PHOTOMETRIC SPECIFICATIONS (CONTINUED)

KT-RDLED38PS-10A-9CSF-VDIM-EM4
POLAR CANDELA DISTRIBUTION

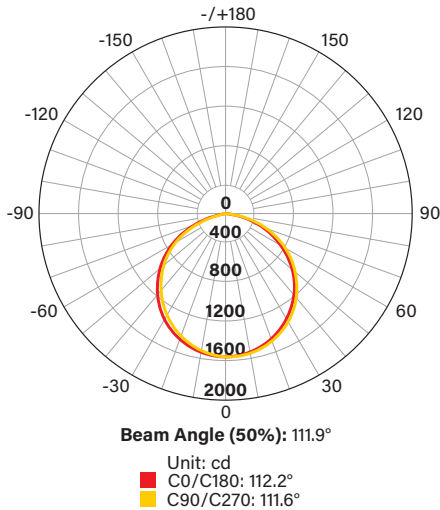

ISOCANDELA PLOT

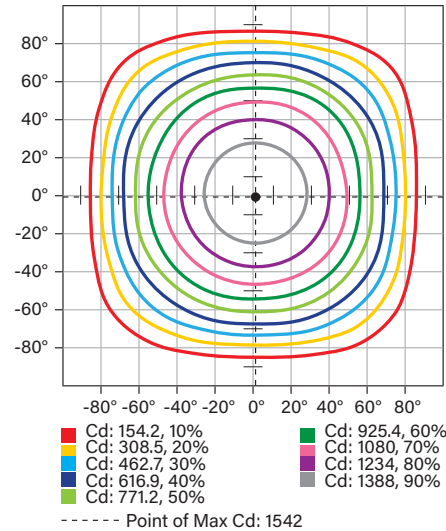

LUX DISTANCE CURVE

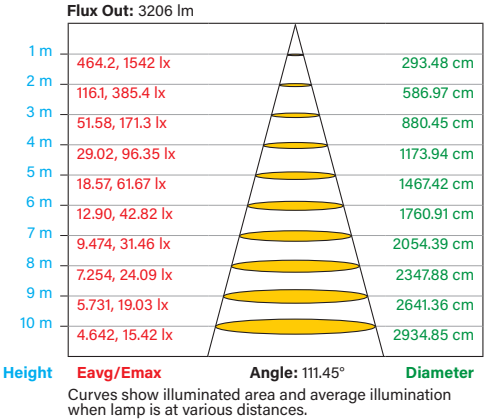

PHYSICAL SPECIFICATIONS

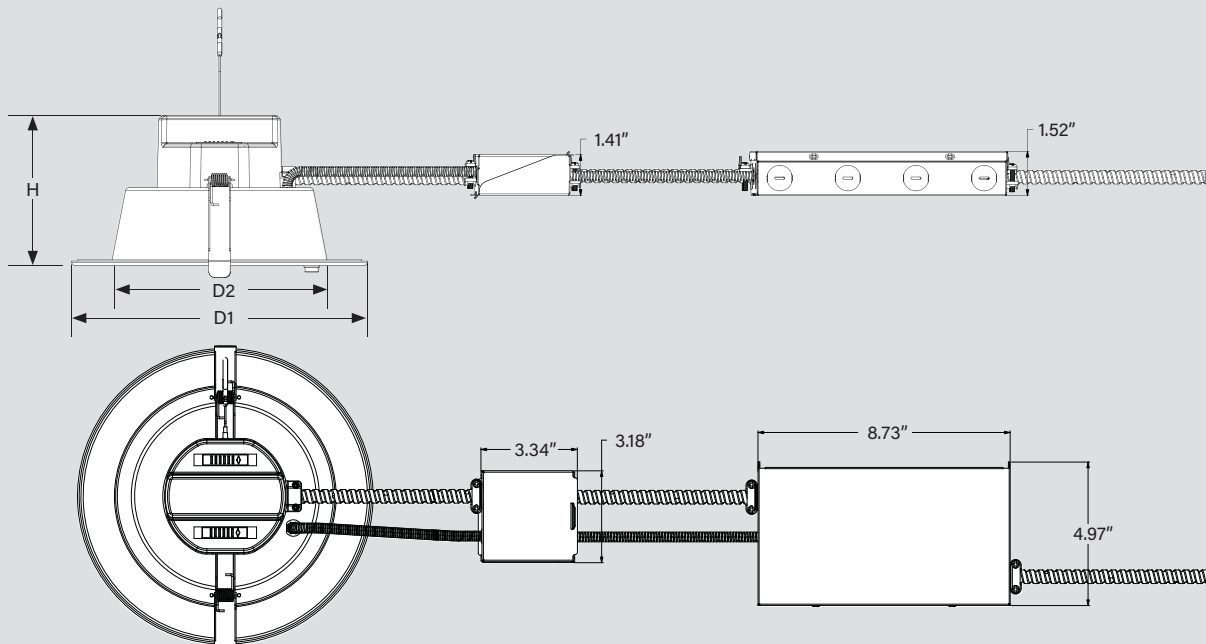

Catalog Number	Size	D1 (Diameter 1)	D2 (Diameter 2)	H (Height)	Cut-Out (Min to Max)
KT-RDLED24PS-6A-9CSF-VDIM-EM4	6"	8.27"	6.02"	4.72"	Ø 6.00" to Ø 7.50"
KT-RDLED30PS-8A-9CSF-VDIM-EM4	8"	10.24"	7.59"	5.20"	Ø 7.56" to Ø 9.44"
KT-RDLED38PS-10A-9CSF-VDIM-EM4	10"	11.30"	8.57"	5.65"	Ø 8.86" to Ø 9.65"

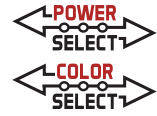

KT-RDLEDXXPS-XA-9CSF-EM4

LED RECESSED EMERGENCY DOWNLIGHT

POWER SELECT (WATTAGE) AND COLOR SELECT (CCT) ADJUSTMENT

This fixture is equipped with field-adjustable Keystone Power Select and Color Select technology.

1. Ensure power is off to the fixture.
2. Adjust dip switches to desired settings.

KT-RDLED24PS-6A-9CSF-VDIM-EM4

Wattage	CCT
24W	2700K
21W	3000K
18.5W	3500K
13W	4000K
9.5W	5000K

KT-RDLED30PS-8A-9CSF-VDIM-EM4

Wattage	CCT
30W	2700K
27W	3000K
23W	3500K
20W	4000K
16W	5000K

KT-RDLED38PS-10A-9CSF-VDIM-EM4

Wattage	CCT
38W	2700K
32W	3000K
28W	3500K
24W	4000K
20W	5000K



COLOR SELECT ADJUSTMENT SWITCH

Set dip switch to adjust CCT between three available CCTs. Fixture comes preset at highest CCT.

POWER SELECT ADJUSTMENT SWITCH

Set dip switch to adjust wattage between three available wattages. Fixture comes preset at highest wattage.

Note: Wattage on dip switch will read 3W higher to account for built-in EM

WIRING SPECIFICATIONS

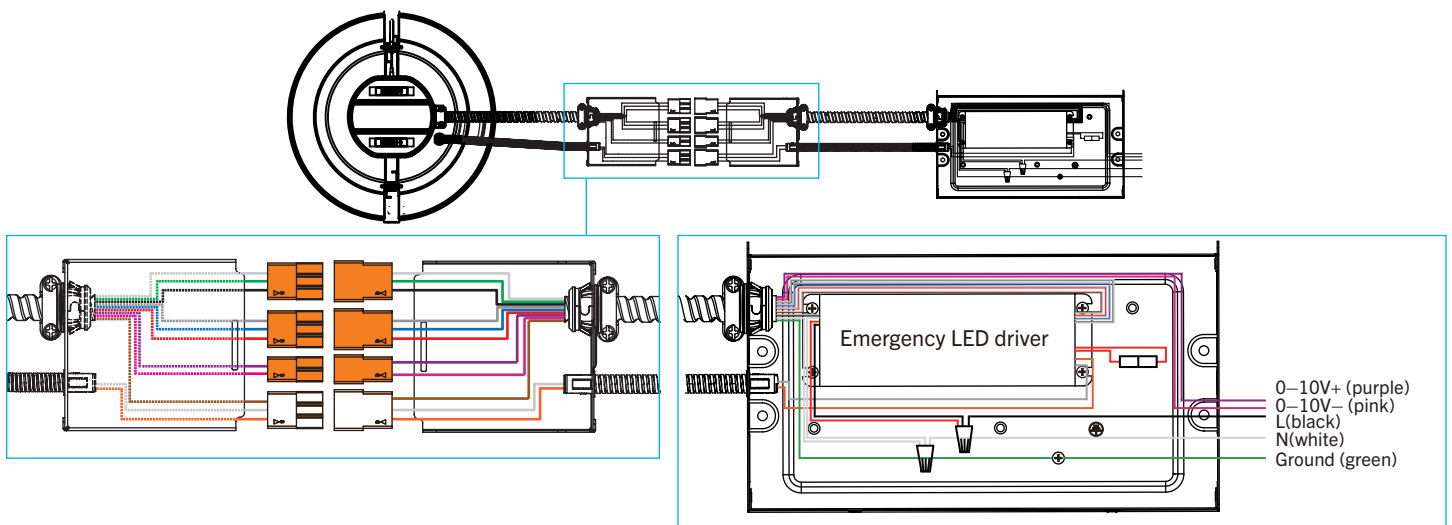

Note: Install in accordance with National Electric Code. Emergency pack and fixture driver must be on the same branch circuit. Ensure hot/live lead going to the black wire on the emergency LED driver is unswitched. When used with switched fixtures, the emergency pack must be wired ahead of the switch.

KT-RDLEDXXPS-XA-9CSF-EM4 LED RECESSED EMERGENCY DOWNLIGHT

INSTALLATION INSTRUCTIONS*

- 1. Shut off power at the source of the fixture housing into which you are installing fixture.**

If retrofit, remove existing trim, CFL/ incandescent bulb, and ballast/ emergency ballast.

Note: Follow all federal and local regulations when disposing of lamps and removed components.

- 2. Use template to cut appropriate sized hole in ceiling for fixture.**
 If retrofit, measure existing ceiling opening to ensure that the edge of the luminaire will cover the entire opening and still sit firmly in the ceiling (see *Dimensions* on page 2).

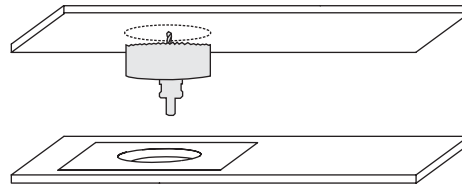

- 3. Select desired Wattage and CCT using adjustment switches on fixture (see *Power Select (Wattage) and Color Select (CCT) Adjustment* on page 3).**

- 4. Attach safety clip to structural point above plenum.**

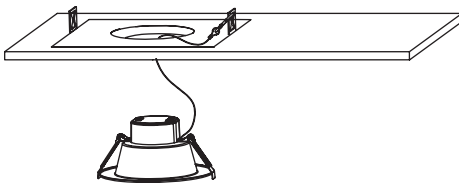

- 5. Insert J-box with EM pack into ceiling and wire to power source. Install in accordance with local and national codes. (See *Wiring Diagram* on page 3). Close J-box cover when done.**

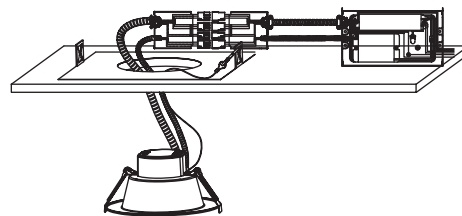

- 6. Push connectors from downlight together with connectors from emergency pack J-box. Note that each connector is keyed to fit only with its corresponding counterpart. Snap connector box together to close.**

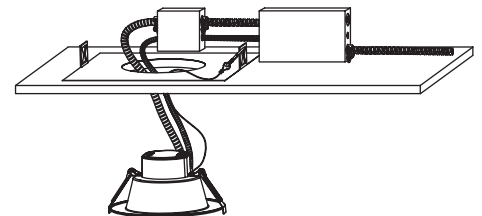

- 7. Squeeze the two housing clips so they are in an upright position and then insert lamp into housing.**

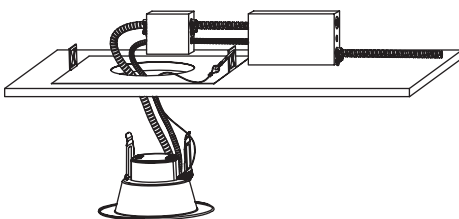

- 8. Once lamp is inside housing, release housing clips and continue to push lamp into housing until securely fixed and flush with ceiling. Restore power.**

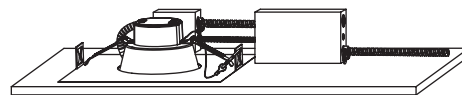

* Keystone offers an optional new-construction plate for both new joist and T-grid installations. See *Optional Accessories* (sold separately) on page 6.



ADVANTA_{EMRG}



KT-RDLEDXXPS-XA-9CSF-EM4 LED RECESSED EMERGENCY DOWNLIGHT

OPERATION

NORMAL MODE

- AC power is present.
- The AC driver operates the LED load as designed.
- The emergency pack is charging in a standby mode.
- The test button will be lit, showing that the battery is charging.
- When battery is fully charged, test button will remain lit.

EMERGENCY MODE

- When the AC power goes out, the emergency pack detects the power outage and automatically switches to the emergency mode.
- The LED load is illuminated for a minimum of 90 minutes.
- The test button will not be lit.
- When AC power is restored, the emergency pack switches back to normal mode and starts re-charging.
- If emergency driver detects battery failure due to problems such as bad contact or charging issues, the test button will not be lit.
- Please contact a qualified electrician for inspection.

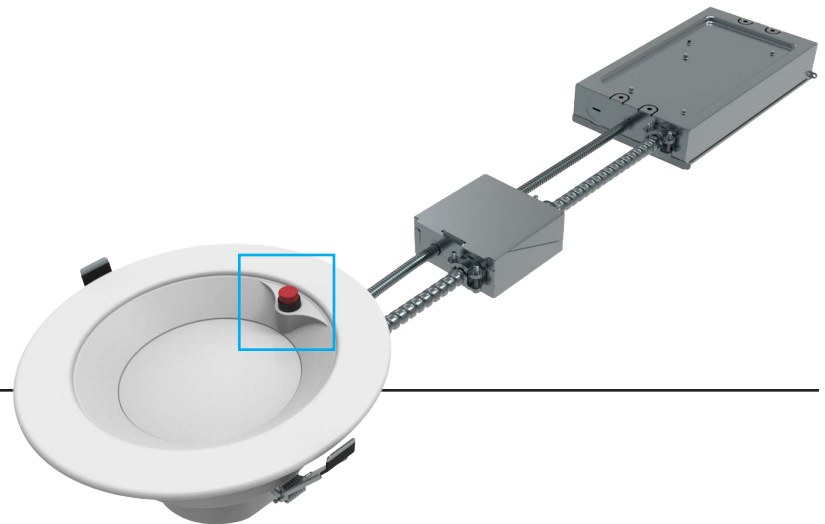

TESTING PROCEDURES

1. Press the test button to cut the power to the AC driver and switch the system to emergency mode.
2. Release the test button to return to normal mode.
3. Switch off the circuit breaker to simulate a full power outage.
4. For initial testing, allow the unit to charge for approximately one (1) hour, then conduct a short discharge test.
5. Allow a 24-hour charge before conducting a one-hour test.

ROUTINE TESTING SCHEDULE

NFPA 101, Life Safety Code outlines the following schedule:

Monthly

1. Ensure that the test button light is illuminated.
2. Conduct a 30-second discharge test by depressing the test button.
3. The LED load should operate at reduced output.

Annually

1. Ensure that the test button is illuminated.
2. Conduct a full 90-minute discharge test.
3. The unit should operate as intended for the duration of the test.

"Written records of the testing shall be kept by the owner for inspection by the authority having jurisdiction."

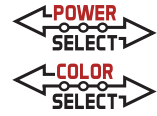

KT-RDLEDXXPS-XA-9CSF-EM4

LED RECESSED EMERGENCY DOWNLIGHT

OPTIONAL ACCESSORIES (sold separately)

INTERCHANGEABLE TRIM

Catalog Number	Description	UPC	Easy Code
KT-RDLED-EM-6A-MB-TRIM	6" Interchangeable trim for 6" recessed emergency downlights; Matte black	843654137339	BRC-30
KT-RDLED-EM-6A-BN-TRIM	6" Interchangeable trim for 6" recessed emergency downlights; Brushed nickel	843654137353	ANR-37



GOOF RING

Catalog Number	Description	UPC	Easy Code
KT-RDLED-6A-GOOF	6" Goof ring for 6" recessed emergency downlights; 10.51" outer diameter	843654137247	LFJ-16

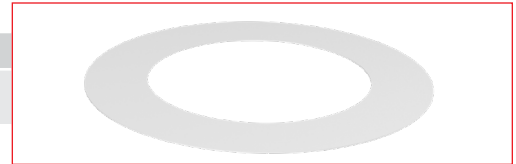

NEW-CONSTRUCTION PLATE

Catalog Number	Description	UPC	Easy Code
KT-RDLED-PLATE-1	New-construction plate for recessed emergency downlights	843654137285	BMS-81

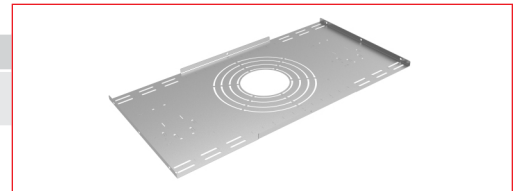

ORDERING INFORMATION

Catalog Number	Pack Qty.	UPC	Easy Code
KT-RDLED24PS-6A-9CSF-VDIM-EM4	1	843654168906	CQY-76
KT-RDLED30PS-8A-9CSF-VDIM-EM4	1	843654168913	UYJ-95
KT-RDLED38PS-10A-9CSF-VDIM-EM4	1	843654168920	TUD-17

CATALOG NUMBER BREAKDOWN

KT-RDLEDXXPS-XA-9CSF-VDIM-EM4

1 2 3 4 5 6 7 8 9 10 11 12 13

1 Keystone Technologies

2 Fixture Type

3 LED Technology

4 Max Wattage

5 Power Select Technology

6 Size

7 Style/Design Designation

8 CRI

9 Color Select Technology

10 Color Select Designation

11 Dimming

12 Emergency Pack

13 Emergency Pack Wattage

2 Fixture Type

RD	Recessed Downlight
----	--------------------

4 Wattage

24	24W
30	30W
38	38W

6 Size

6	6" Nominal
8	8" Nominal
10	10" Nominal

10 Color Select Designation

E	3000K, 3500K, 4000K
---	---------------------