

# KT-WPLED35PS-S3-8CSB-VDIM

## ADJUSTABLE WALL PACK

### DESCRIPTION

0° - 90° Adjustable LED Wall Pack | Power Select | Color Select | 120-277V | Bronze Housing

### APPLICATION

Commercial wall mount applications for outdoor illumination (alleys, pathways, landscape lighting)



### PRODUCT FEATURES

- Keystone Power Select technology (35/25/15W)
- Keystone Color Select technology (3000/4000/5000K)
- 0° - 90° field adjustable light positioning to illuminate areas missed by traditional forward throw wall packs
- Heavy duty, die cast aluminum housing with enhanced performance and reliability
- Built in dusk to dawn photocell behind translucent 3/4" threaded plug with antiyellowing agent
- Powered by Keystone 0–10V dimming LED drivers
- Ambient operating temperature: -40°C/-40°F - 50°C/122°F
- UL certified, IP65 rated
- THD: < 20%
- LED chip lifetime: L70 > 100,000 hrs @ 25°C/77°F ambient fixture temperature
- Meets FCC Part 15, Part B, Class A standards for conducted and radiated emissions

### PRODUCT SPECIFICATIONS

| Catalog Number            | Wattage | CCT   | Lumens | Efficacy | Dimming | CRI | Input Voltage | Photocell | Housing Color | Rated Life | Legacy Equivalent |
|---------------------------|---------|-------|--------|----------|---------|-----|---------------|-----------|---------------|------------|-------------------|
| KT-WPLED35PS-S3-8CSB-VDIM | 35W     | 3000K | 4375   | 125 lm/W | 0–10V   | >80 | 120–277V      | Included  | Bronze        | 50,000 hrs | 150W MH           |
|                           |         | 4000K | 5075   | 145 lm/W |         |     |               |           |               |            |                   |
|                           |         | 5000K | 4725   | 135 lm/W |         |     |               |           |               |            |                   |
|                           | 25W     | 3000K | 3375   | 135 lm/W |         |     |               |           |               |            |                   |
|                           |         | 4000K | 3750   | 150 lm/W |         |     |               |           |               |            |                   |
|                           |         | 5000K | 3625   | 145 lm/W |         |     |               |           |               |            |                   |
|                           | 15W     | 3000K | 2178   | 145 lm/W |         |     |               |           |               |            |                   |
|                           |         | 4000K | 2325   | 155 lm/W |         |     |               |           |               |            |                   |
|                           |         | 5000K | 2250   | 150 lm/W |         |     |               |           |               |            |                   |

### PHYSICAL SPECIFICATIONS

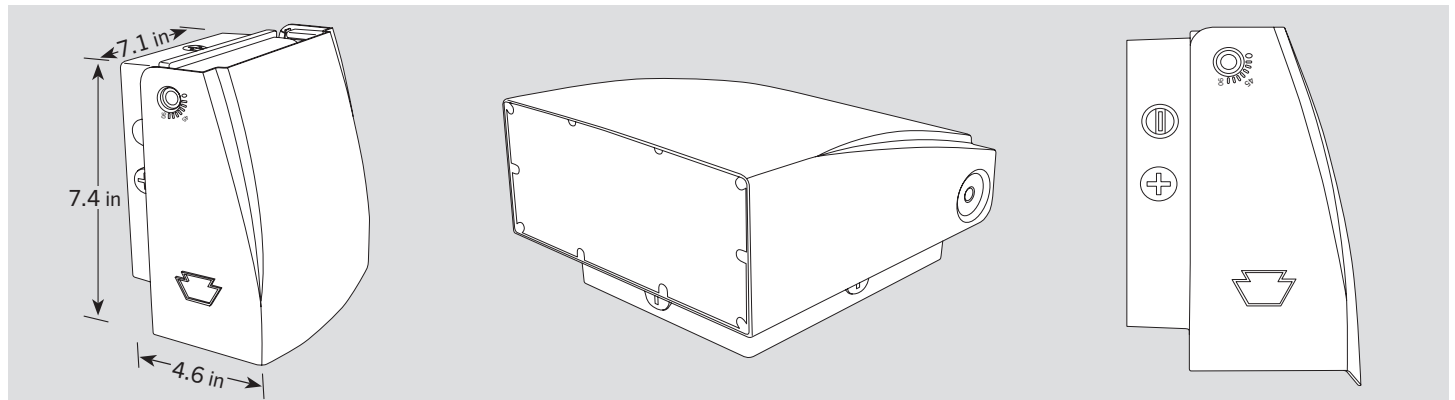

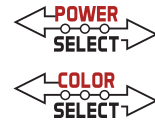

# KT-WPLED35PS-S3-8CSB-VDIM

## ADJUSTABLE WALL PACK

### GENERAL SETUP INSTRUCTIONS

#### GENERAL WIRING DIAGRAM

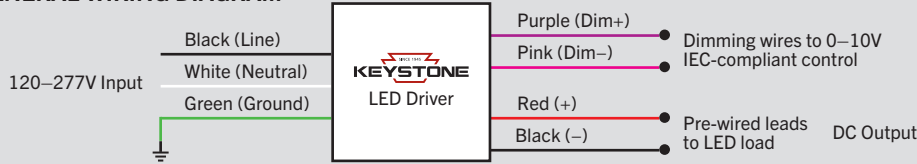

**Caution:** Before installing, make certain that AC power to the fixture is off.

**Caution:** The electrical rating of this product is 120–277V. Installer must confirm that there is 120–277V at the fixture before installation.

Note: \*In accordance with NEC-20 410.69 2022, all 0-10V negative wires have been updated from gray to pink. Please contact Keystone for details

#### ANGLE ADJUSTMENT INSTRUCTIONS

1. Loosen the screw on the side of the housing using an Allen wrench.
2. Adjust housing to desired setting, 0° - 90° in 15° intervals.
3. Tighten the screw on the side of the housing using the Allen wrench in Step 1.

#### PHOTOCELL AND CCT ADJUSTMENT

This fixture is equipped with a dusk to dawn photocell behind the translucent knockout (KO). Enable or disable the photocell by removing the cap and adjusting the dip switch to your desired setting. Fixture comes preset with photocell enabled. This fixture is also equipped with Keystone Color Select technology. The CCT dip switch is located in the same KO as the photocell. Remove the cap and adjust to your desired setting. This fixture comes preset to 5000K.

#### WATTAGE ADJUSTMENT

This fixture is equipped with Keystone Power Select technology. The adjustable knob is located in the driver compartment. See instructions below on how to access. Fixture comes preset to either 75W or 35W, depending on model ordered.

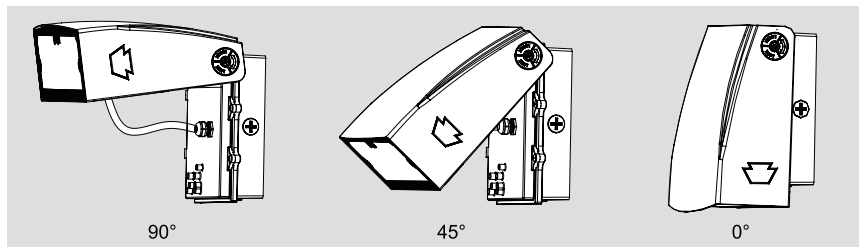
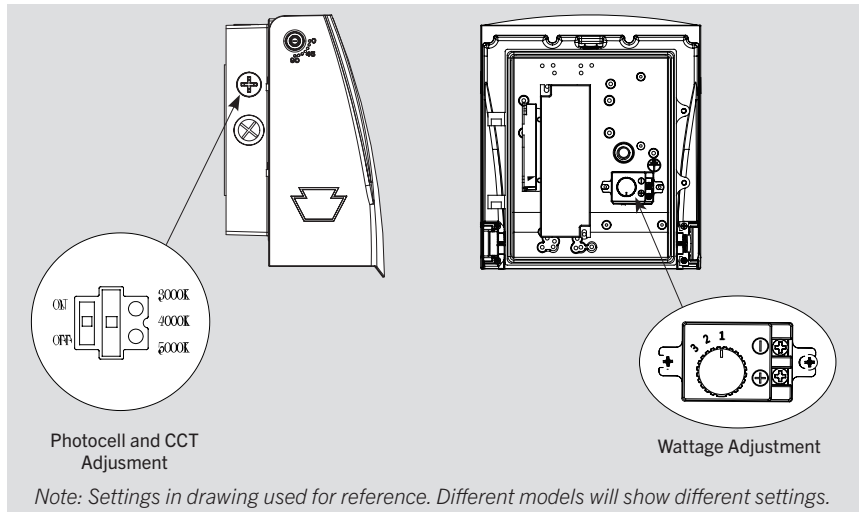

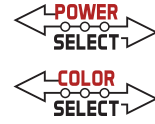

# KT-WPLED35PS-S3-8CSB-VDIM

## ADJUSTABLE WALL PACK

### PHOTOMETRICS SPECIFICATIONS

Full cutoff wall pack  
35W 5000K  
Building mounted 15'

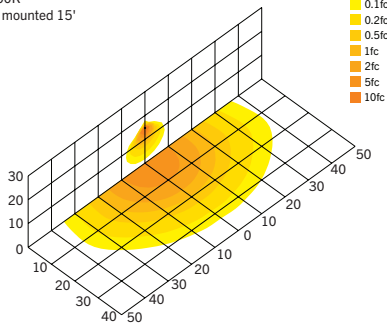

Full cutoff wall pack  
25W 5000K  
Building mounted 15'

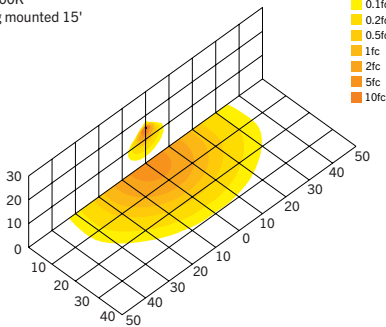

Full cutoff wall pack  
15W 5000K  
Building mounted 15'

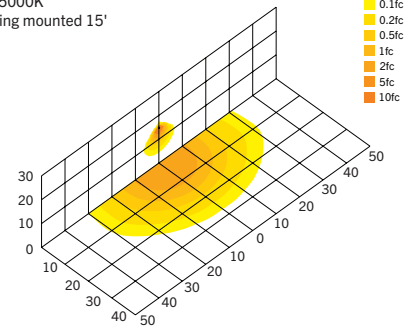

Luminous Intensity Distribution Curve

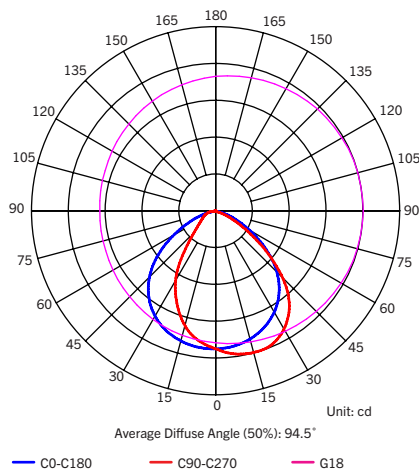

Isocandela (Rectangle)

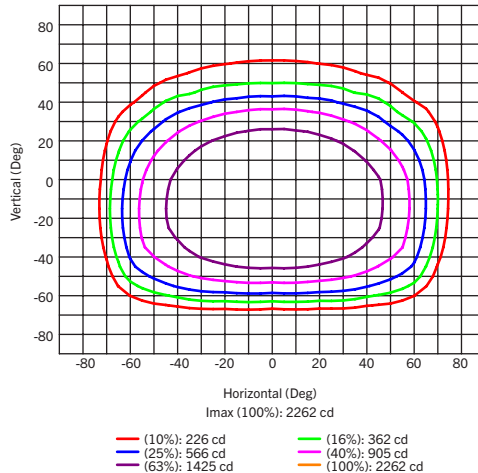

| ZONE                 | LUMENS      | % LAMP LUMENS |
|----------------------|-------------|---------------|
| <b>FORWARD LIGHT</b> | <b>2938</b> | <b>60.3</b>   |
| FL (0° - 30°)        | 904         | 18.6          |
| FM (30° - 60°)       | 1674        | 34.4          |
| FH (60° - 80°)       | 352         | 7.2           |
| FVH (80° - 90°)      | 9           | 0.2           |

|                   |             |             |
|-------------------|-------------|-------------|
| <b>BACK LIGHT</b> | <b>1886</b> | <b>38.7</b> |
| BL (0° - 30°)     | 768         | 15.8        |
| BM (30° - 60°)    | 917         | 18.8        |
| BH (60° - 80°)    | 175         | 3.6         |
| BVH (80° - 90°)   | 23          | 0.5         |

|                  |           |            |
|------------------|-----------|------------|
| <b>UP LIGHT</b>  | <b>49</b> | <b>1.0</b> |
| UL (90° - 100°)  | 5         | 0.1        |
| UH (100° - 180°) | 44        | 0.9        |

|                      |           |           |
|----------------------|-----------|-----------|
| <b>TRAPPED LIGHT</b> | <b>NA</b> | <b>NA</b> |
|----------------------|-----------|-----------|

| BUG (Backlight, Uplight, Glare) Rating<br>Base On TM-15-07           |          |
|--|----------|
| Asymmetrical Luminaire Types<br>(Type I, II, III, IV)                | B2 U2 G1 |
| Quadrilateral Symmetrical<br>Luminaire Types<br>(Type V, Area Light) | B2 U2 G1 |

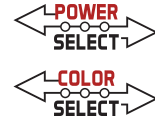

# KT-WPLED35PS-S3-8CSB-VDIM

## ADJUSTABLE WALL PACK

### ACCESSORIES

#### CORD SETS

Factory-Installable OR Field-Installable (field-installable purchased separately)

| ✓ | SUFFIX* | CATALOG NUMBER     | DESCRIPTION  | UPC          | EASY CODE |
|---|---------|--------------------|--|--------------|-----------|
|   | /515P6  | KT-CS-515P-6-18/3  | Cord set for high bay; 125V NEMA 5-15P; straight blade plug; 6' SJTOW cable; 18/3 wire | 843654140124 | UKH-26    |
|   | /L515P6 | KT-CS-L515P-6-16/3 | Cord set for high bays; 250V NEMA L5-15P; twist lock plug; 6' SJTOW cable; 16/3 wire   | 843654140186 | POC-82    |

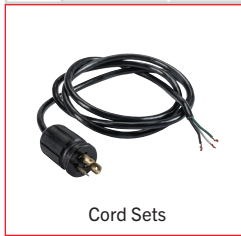

Cord Sets

\* For factory installation of accessory, add suffix to fixture part number (see ordering examples and instructions on last page of spec sheet).  
 Note: For cord sets not listed here, please contact your Keystone sales rep.

#### EMERGENCY BACKUP

Field-Installable (purchased separately)

| ✓ | SUFFIX* | CATALOG NUMBER       | DESCRIPTION   | UPC          | EASY CODE |
|---|---------|----------------------|---|--------------|-----------|
|   | -       | KT-EMRG-LED-12C-1200 | LED Emergency Back-Up, 12W Constant Wattage Design. Approx 1200 Lumens. 120-277V Input. Remote Compact Battery Pack. CEC T20 Compliant. | 843654103112 | OJQ-32    |
|   | -       | KT-EMRG-LED2-TS-IP65 | IP65 Rated Wet Location Test Switch for 5W and 12W CEC Compliant LED Emergency Packs  | 843654130019 | MDB-29    |

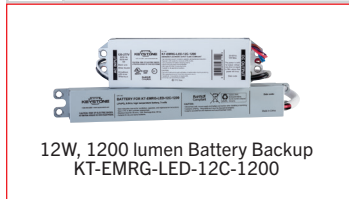

12W, 1200 lumen Battery Backup  
KT-EMRG-LED-12C-1200

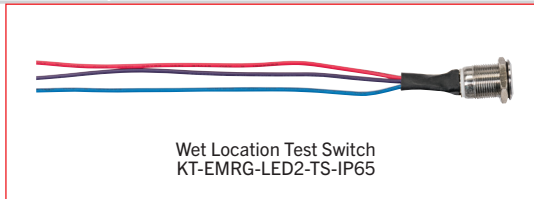

Wet Location Test Switch  
KT-EMRG-LED2-TS-IP65

#### SURGE PROTECTORS

Factory-Installable OR Field-Installable (field-installable purchased separately)

| ✓ | SUFFIX* | CATALOG NUMBER | DESCRIPTION   | UPC          | EASY CODE |
|---|---------|----------------|---|--------------|-----------|
|   | /10KV   | KTSP-10KV-C    | External Surge Protector, compact design. Parallel Wiring, 120-277V Input, Max Peak Protection (10KV, 10KA) | 843654129204 | BUU-26    |



External Surge Protector  
KTSP-10KV-C

\* For factory installation of accessory, add suffix to fixture part number (see ordering examples and instructions on last page of spec sheet).

